

# TABLE SCALES WLC/R

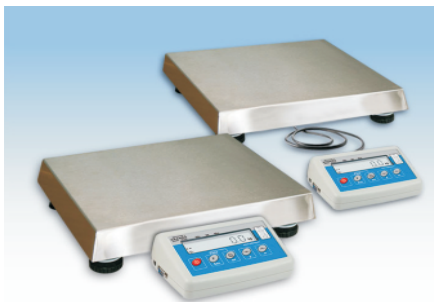





release date 05-01-2012



Scales series WLC/R are designed for fast and precise mass determination particularly in direct trade and in laboratory and industrial conditions. They are easily utilized in areas with access to mains (230V), as their standard equipment includes internal rechargeable accumulator and RS 232 output. All models of WLC/R scales (pan size: 128×128, 125×145, 195×195, 290×360 and 400×500 mm) feature stainless steel weighing platform and backlit LCD display providing good reading of weighing result.

Series WLC A2 offers the possibility of weighing loads outside weighing platform (so called under hook weighing). where the load is hanged under the instrument. This is an alternative for weighing loads with non-standard dimensions and shapes.

-  Counting pieces
-  Checkweighing
-  Percent setup
-  Peak hold
-  Measurement in Newton

## Technical data:

	WLC 0,6/B1	WLC 1,2/B1	WLC 1,2/3/A1	WLC 3/6/A2	WLC 6/12/A2
Max capacity	0,6 kg	1,2 kg	1,2/3 kg	3/6 kg	6/12 kg
Readability	0,1 g	0,2 g	0,2/0,5 g	0,5/1 g	1/2 g
Tare range	-0,6 kg	-1,2 kg	-3 kg	-6 kg	-10 kg
Pan size	125 × 145 mm		195 × 195 mm		
Power supply	230V / 11V AC or 120V / 11V AC, internal battery SLA 3,4 Ah				
Output signal	RS 232				
Stabilization time	3 s				
IP rating	IP 43				
Working temperature	+15° - +30 °C				
Display	LCD (backlit)				
Net weight / Gross weight	1,1 / 2 kg		2,8 / 3,8 kg		
Packaging dimensions	320×210×150 mm		440×280×190 mm		

## Technical data:

	WLC 6/12/C1/R WLC 6/12/C1/K	WLC 12/30/C1/R WLC 12/30/C1/K	WLC 30/60/C2/R WLC 30/60/C2/K	WLC 60/120/C2/R WLC 60/120/C2/K
Max capacity	6/12 kg	12/30 kg	30/60 kg	60/120 kg
Readability	1/2 g	2/5 g	5 / 10 g	10/20 g
Tare range	-6 kg	-12 kg	-60 kg	-60 kg
Pan size	290 × 360 mm		400 × 500 mm	
Power supply	230V / 11V AC or 120V / 11V AC and 6 × AA NiMH			
Output signal	RS 232			
Stabilization time	3 s			
IP rating	IP 43			
Working temperature	+15° - +30 °C			
Display	LCD (backlit)			
Net weight / Gross weight	6,7 / 7,8 kg		15,5 / 17,8 kg	
Packaging dimensions	550×420×220 mm		720×580×220 mm	

## Additional equipment:

"KAFKA" THERMAL PRINTER

COMPUTER SOFTWARE PW-WIN, RAD-KEY, REC-FS

"EPSON" IMPACT PRINTER

LCD ADDITIONAL DISPLAY

RACK FOR UNDER HOOK WEIGHING

TARE AND PRINT FOOT BUTTONS

SUITCASE FOR SCALE

B1 version

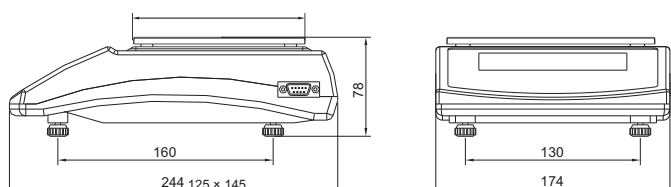

A2 version

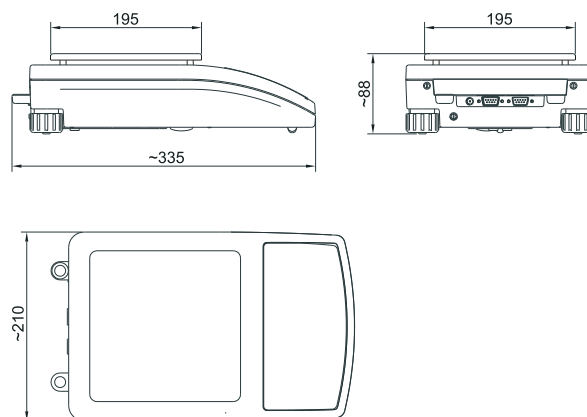

/K version

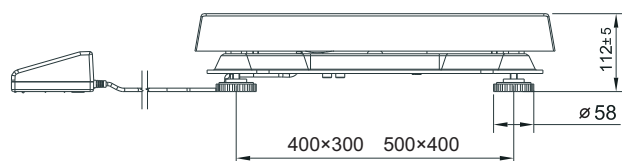

/R version

